

Test Report

for 1.0~8.0GHz Broadband Horn Antenna



Model: **HXATBDH1080B**

Chengdu HAIXIN MICROWAVE Technology Co., Ltd

Add: Chengdu 610091, China

Tel: +86-28-87089208

Website: www.hxmicrowave.com

Fax: +86-28-87089208

Email: sale@hxmicrowave.com

Outline Drawing (Size: mm)

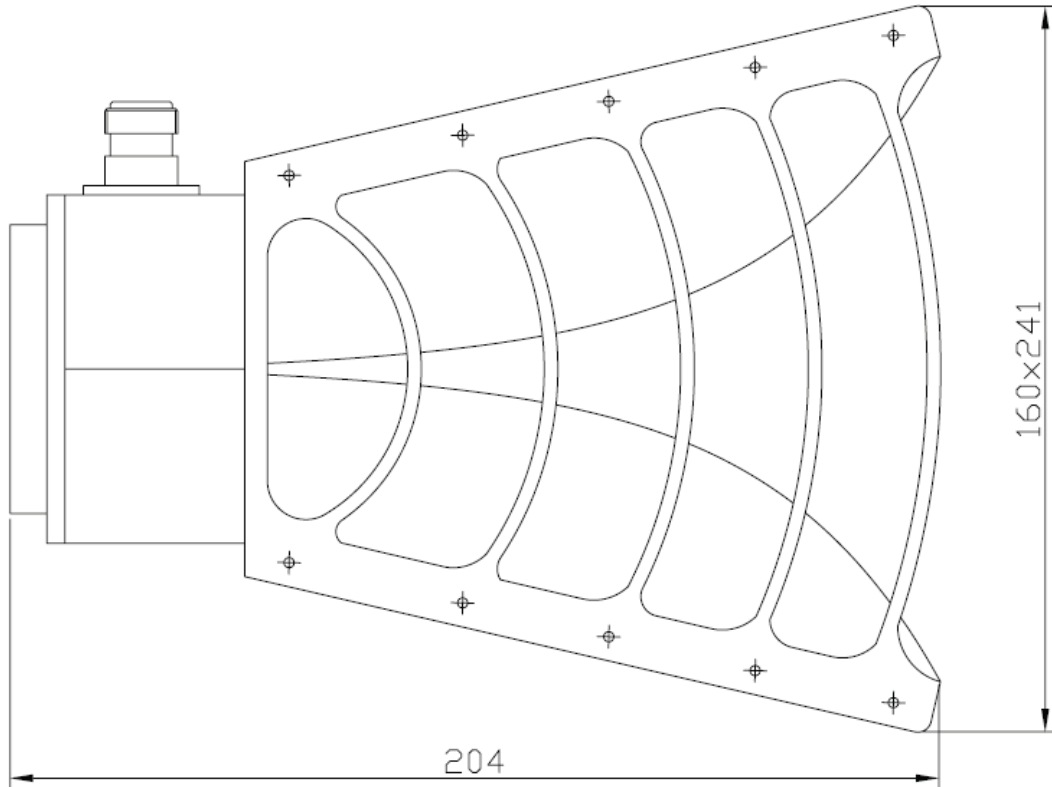

Technical Specification

Frequency Rang	VSWR	Gain	Connector	Size
1.0~8.0GHz	2:1	10dBi	N-Female	204mm×160mm×241mm

Test Instruments

Agilent 83630B
HP8563E
HP8720D

Chengdu HAXIN MICROWAVE Technology Co., Ltd

Add: Chengdu 610091, China
Tel: +86-28-87089208
Website: www.hxmicrowave.com

Fax: +86-28-87089208

Email: sale@hxmicrowave.com

Test Results

1. Gain



Frequency (GHz)	1.0	2.0	4.0	6.0	8.0
Gain (dBi)	7	10.2	10.5	12	13

2. Pattern

1000MHz

E Plane(90°)

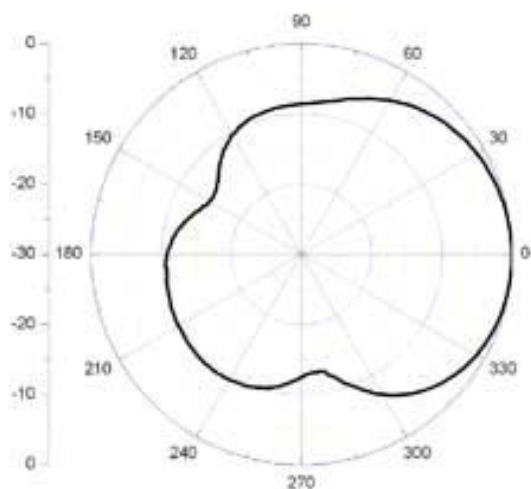

H Plane(72°)

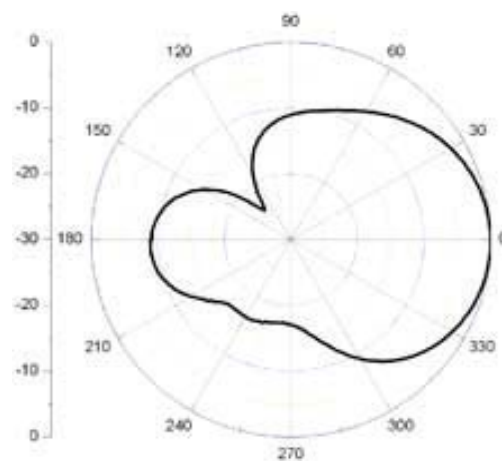

300
0M
Hz

Pla
ne(
44
°)
H
Pla

ne(67°)

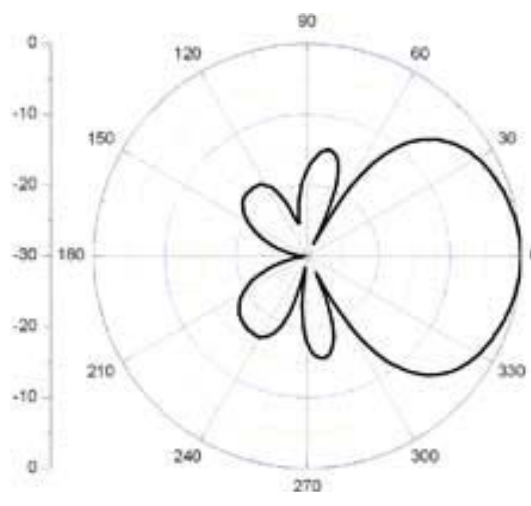
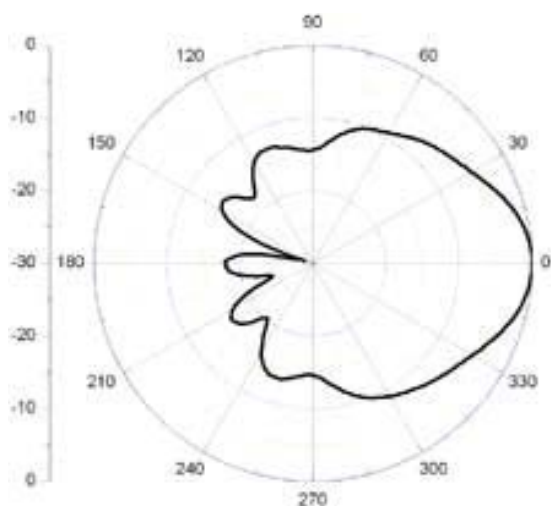

6000MHz

Chengdu HAIXIN MICROWAVE Technology Co., Ltd

Add: Chengdu 610091, China

Tel: +86-28-87089208

Website: www.hxmicrowave.com

Fax: +86-28-87089208

Email: sale@hxmicrowave.com

E Plane(40°)

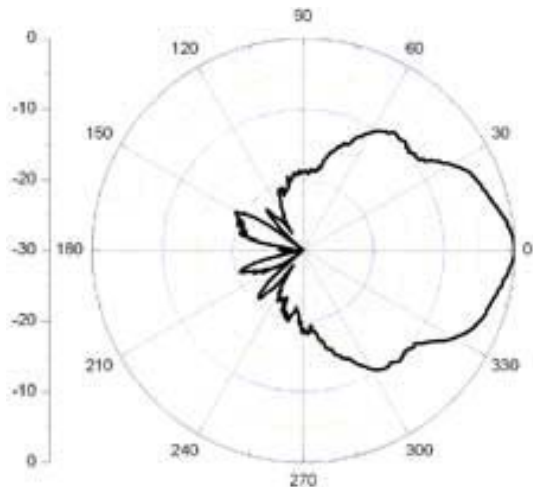

H Plane(34°)

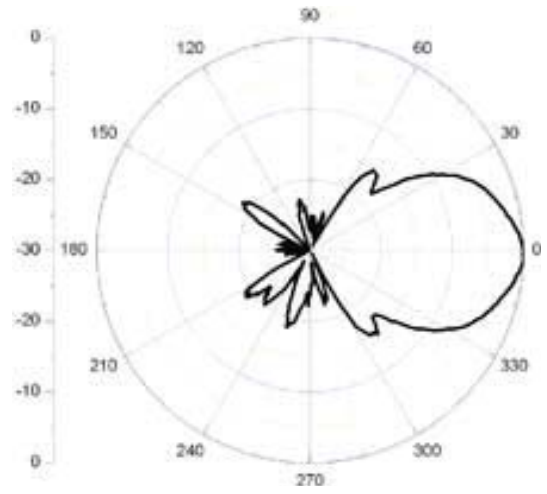

8000MHz

E Plane(40°)

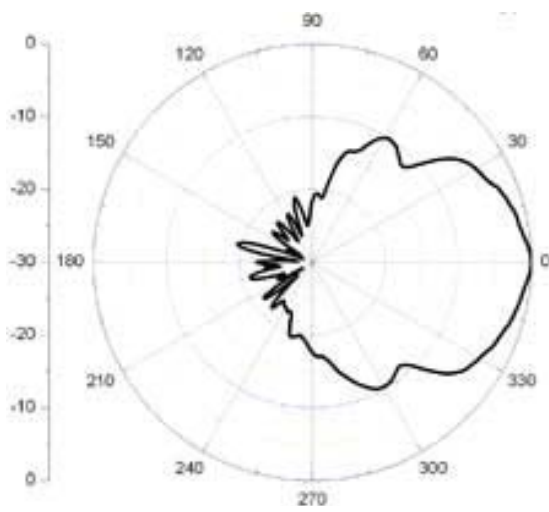

H Plane(34°)

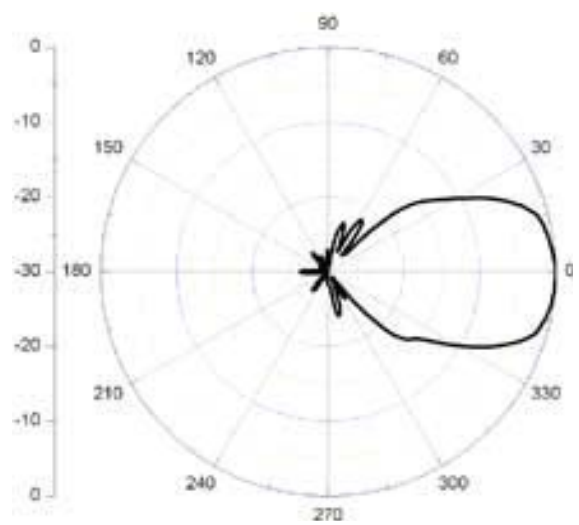

Chengdu SIWI Electronic Co., Ltd

Add: SIWI Electronic Building, Xiejiaqi, Chengdu 610091, China

Tel: +86-28-81705119 87360620

Website: www.siwi.com.cn

Fax: +86-28-81707519

Email: market@siwi.com.cn